

STEP 1.

NOTE:
ALL CONSTRUCTION MUST BE COMPLETE BEFORE PRODUCT ARRIVES
PRODUCT MUST ACCLIMATE AT LEAST 48 HOURS BEFORE INSTALLING
AREA MUST BE CLEAN, DEBRIS-FREE, & DUST-FREE
READ WARRANTY NOTICE FOR MORE INFORMATION

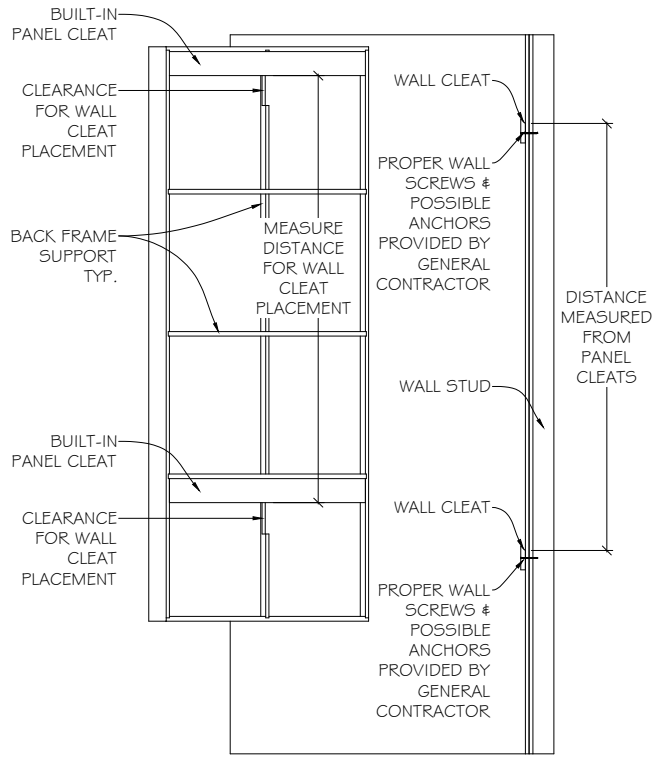

RIGHT VIEW

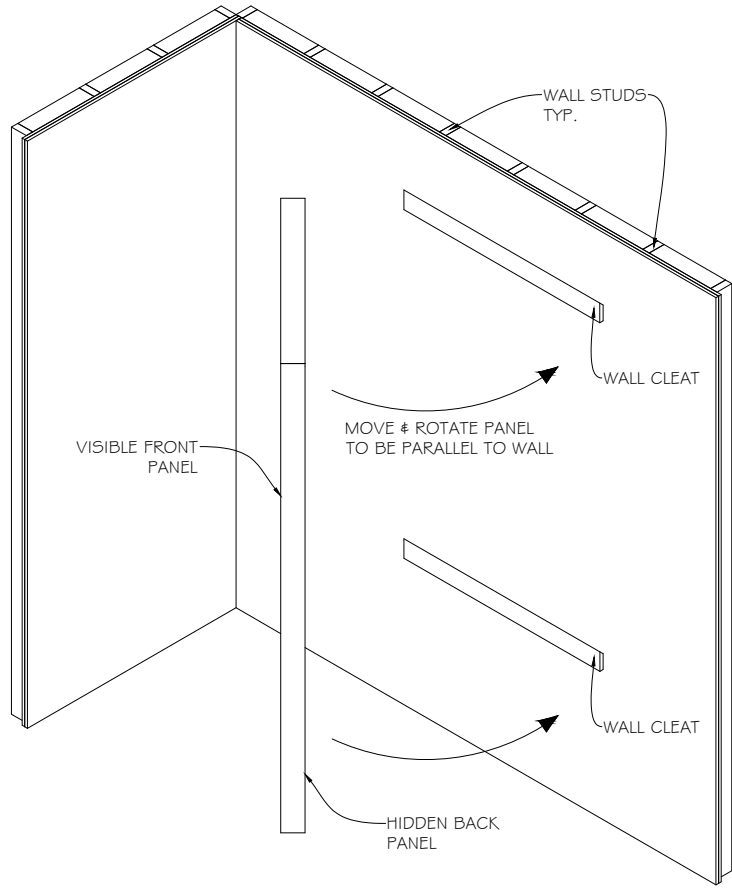

ISOMETRIC VIEW

STEP 2.

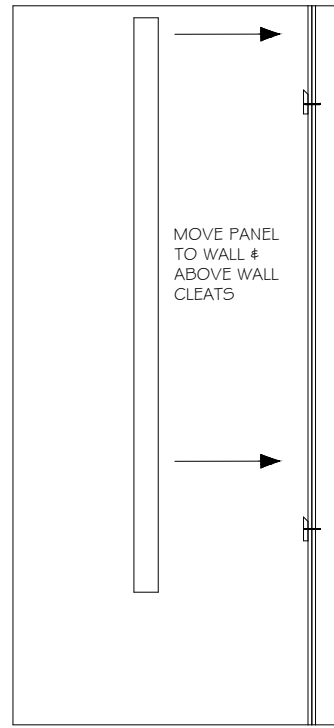

RIGHT VIEW

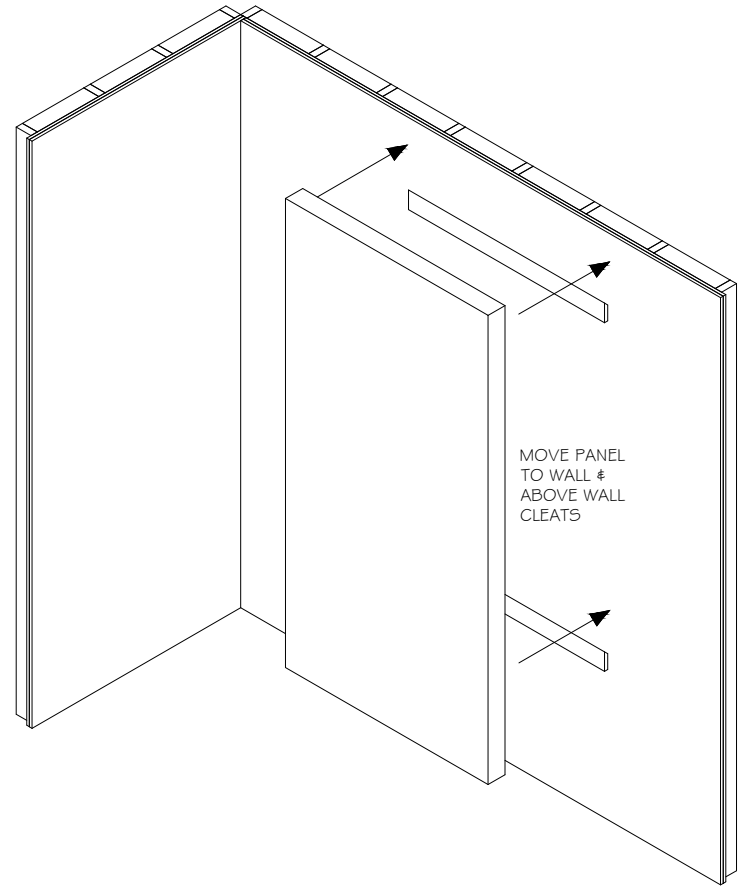

ISOMETRIC VIEW

STEP 3.

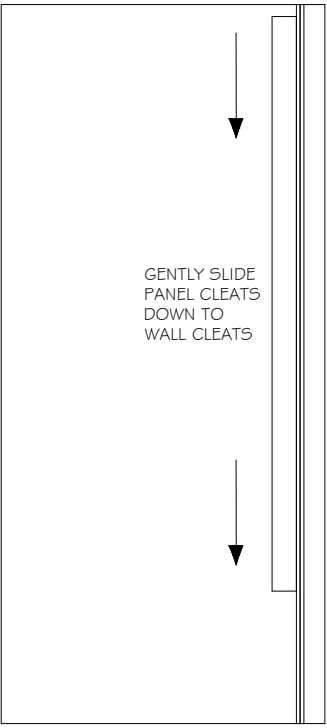

RIGHT VIEW

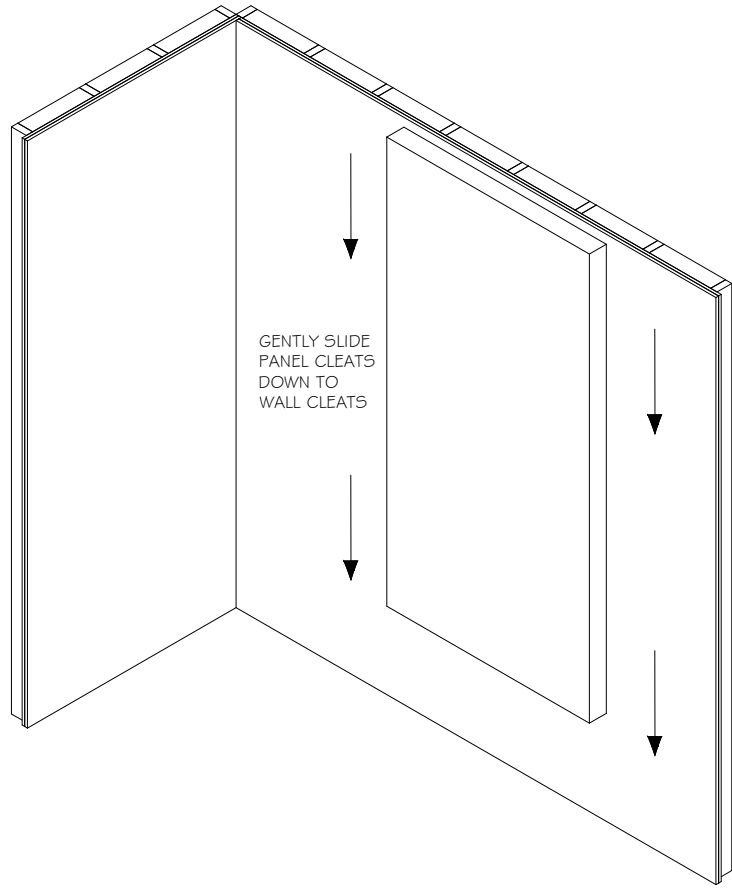

ISOMETRIC VIEW

STEP 4.

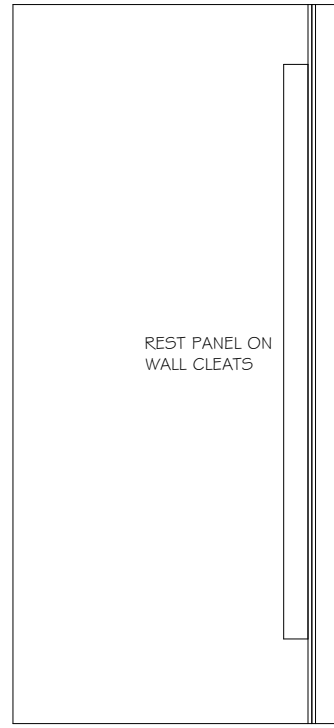

RIGHT VIEW

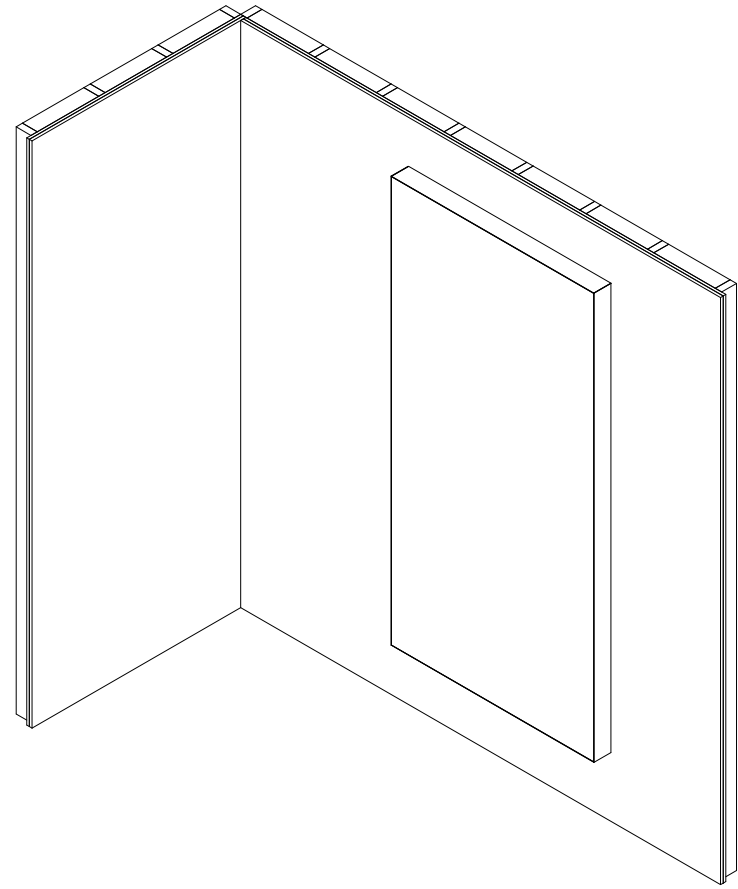

ISOMETRIC VIEW



801-782-1010
2361 B AVE
OGDEN, UTAH 84401
INFO@REALACOUSTIX.COM

INSTALLATION

FLUSH FRAME WALL

PLEASE NOTE THAT THESE INSTRUCTIONS ARE FOR GUIDANCE ONLY. REALACOUSTIX LLC, ITS OWNERS, EMPLOYEES AND STAFF SHALL ASSUME NO LIABILITY FOR THE COMPREHENSION OF THESE INSTRUCTIONS OR THE FOLLOWING THEREOF. NO LIABILITY ON THE PART OF REALACOUSTIX LLC SHALL BE ASSUMED FOR THE WORK INVOLVED IN INSTALLATION OF ITS PRODUCTS BY OTHERS. PLEASE NOTE THAT ALL SAFE PRACTICES AS SPECIFIED BY THE LOCAL BUILDING CODES, OSHA, AND OTHER STANDARD ORGANIZATIONS SHOULD BE FOLLOWED IN THE SELECTION OF MATERIALS AND/OR METHODS USED IN HANGING, MOUNTING, OR INSTALLING REALACOUSTIX LLC PRODUCTS.

PROPRIETARY AND CONFIDENTIAL

THE INFORMATION CONTAINED IN THIS DRAWING IS THE SOLE PROPERTY OF REALACOUSTIX LLC. ANY REPRODUCTION IN PART OR AS A WHOLE WITHOUT THE WRITTEN PERMISSION OF REALACOUSTIX LLC. IS PROHIBITED

REALACOUSTIX LLC RESERVES THE RIGHT TO CHANGE OR MODIFY PRODUCTS ILLUSTRATED IN THE SHOP DRAWINGS AS NEEDED FOR ANY REASON DEEMS NECESSARY TO IMPROVE THE DESIGN OR MEET CERTAIN WEIGHT, MEASUREMENT, VISUAL, ARCHITECTURAL OR STRUCTURAL REQUIREMENTS.

DRAFTED BY: AB
CHECKED BY:

MODIFIED DATE:
9/9/22

REVISION NUMBER: 1

SD-A02

STEP 1.

NOTE:
ALL CONSTRUCTION MUST BE COMPLETE BEFORE PRODUCT ARRIVES
PRODUCT MUST ACCLIMATE AT LEAST 48 HOURS BEFORE INSTALLING
AREA MUST BE CLEAN, DEBRIS-FREE, & DUST-FREE
READ WARRANTY NOTICE FOR MORE INFORMATION

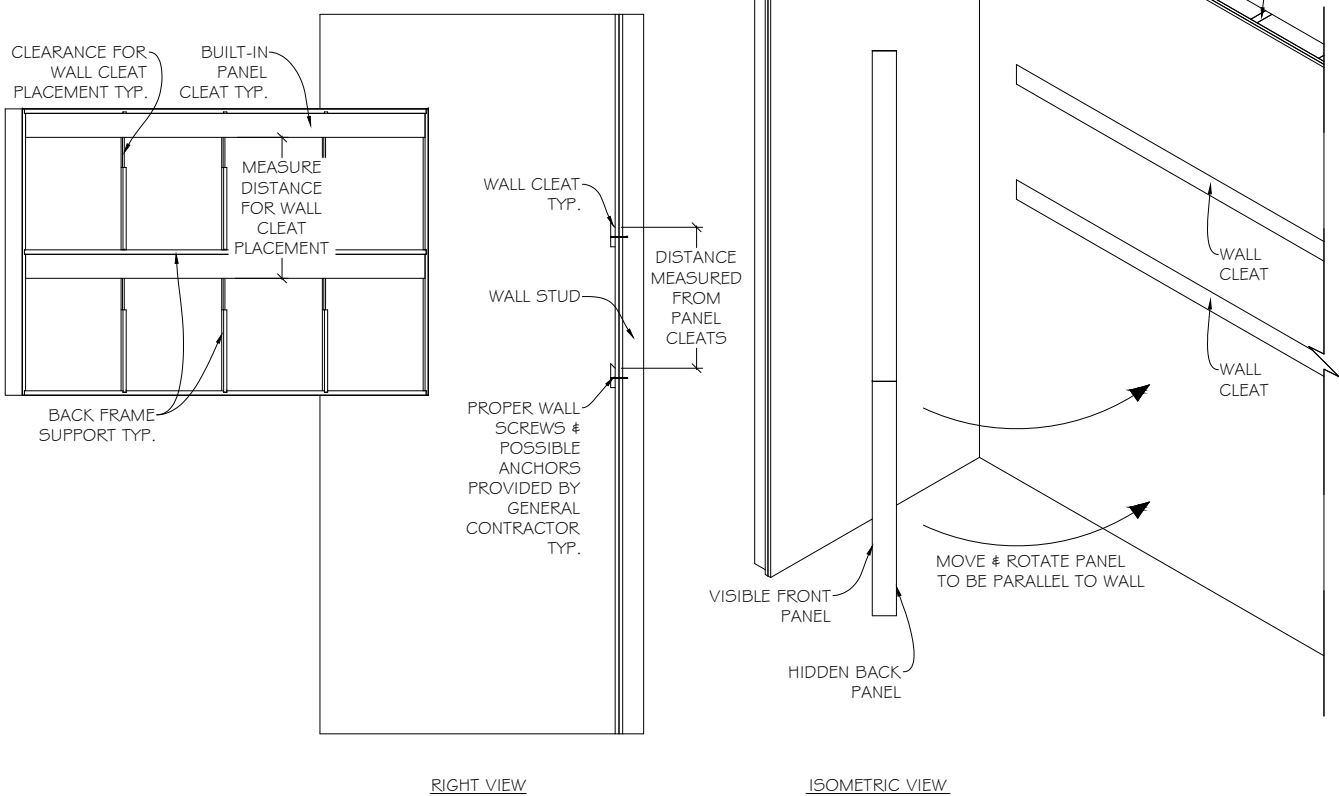

STEP 2.

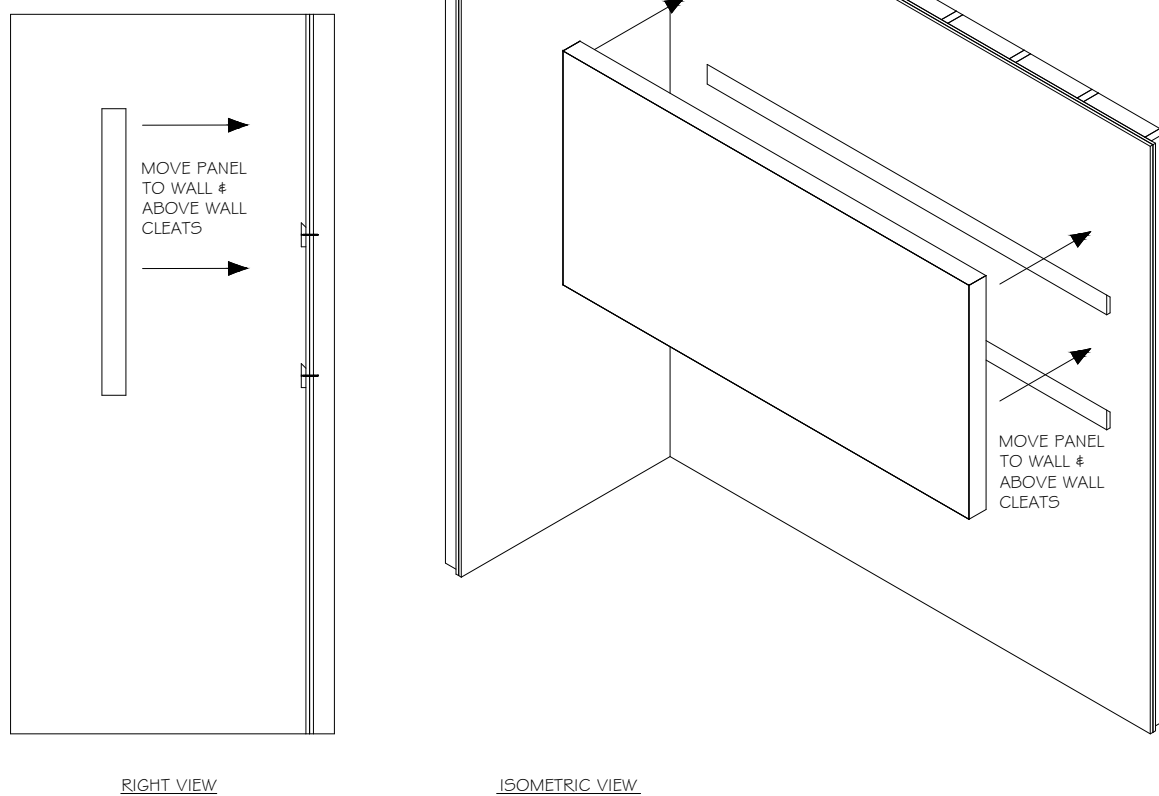

STEP 3.

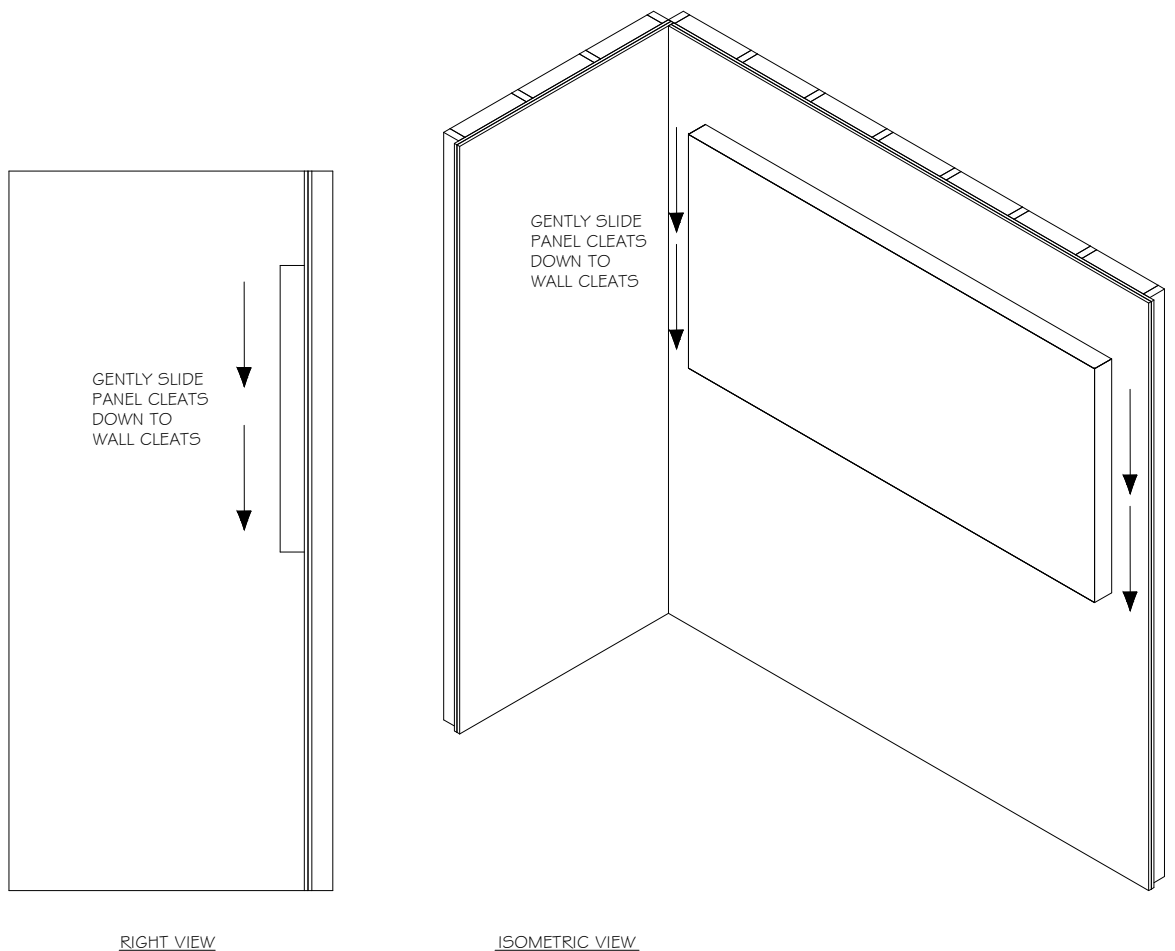

STEP 4.

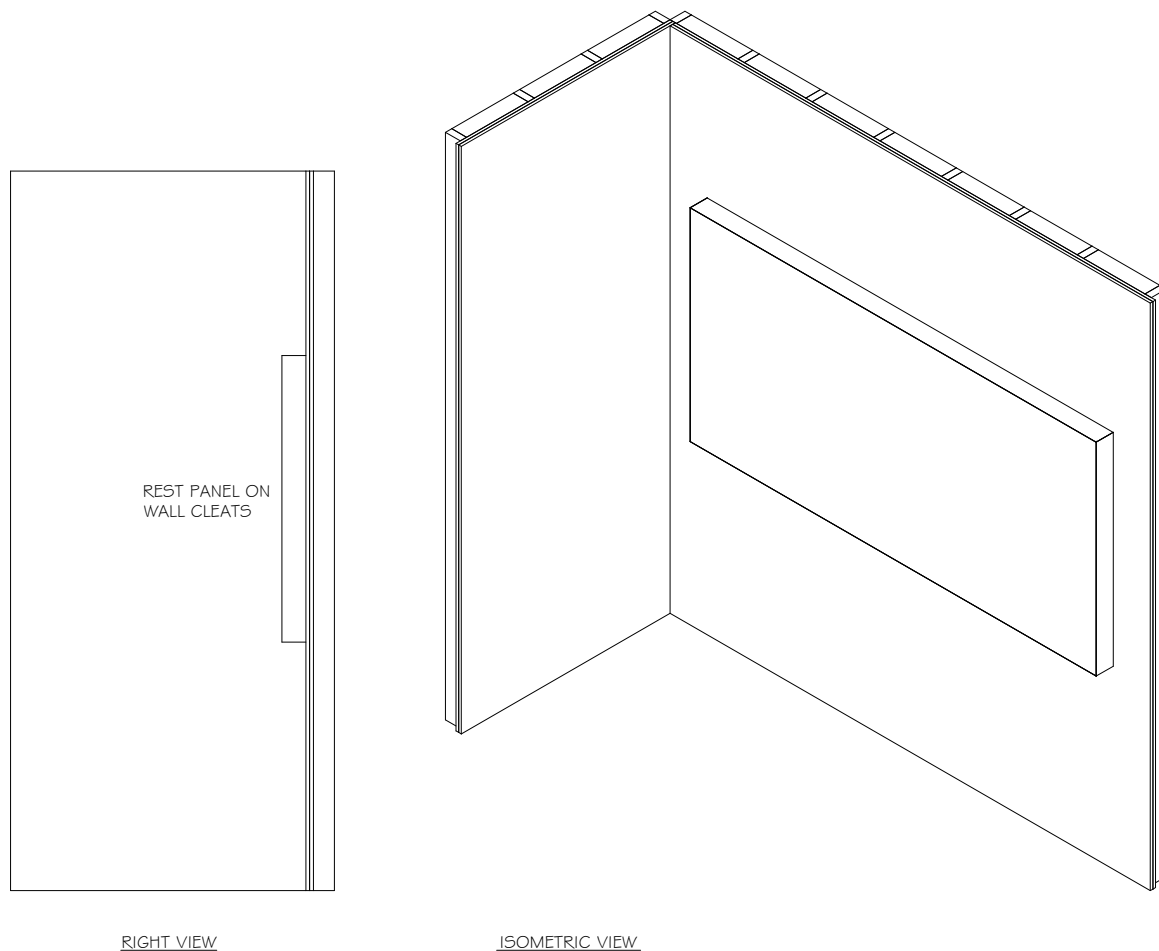

Real Acoustix
801-782-1010
2361 B AVE
OGDEN, UTAH 84401
INFO@REALACOUSTIX.COM

INSTALLATION
FLUSH FRAME WALL

PLEASE NOTE THAT THESE INSTRUCTIONS ARE FOR GUIDANCE ONLY. REALACOUSTIX LLC, ITS OWNERS, EMPLOYEES AND STAFF SHALL ASSUME NO LIABILITY FOR THE COMPREHENSION OF THESE INSTRUCTIONS OR THE FOLLOWING THEREOF. NO LIABILITY ON THE PART OF REALACOUSTIX LLC SHALL BE ASSUMED FOR THE WORK INVOLVED IN INSTALLATION OF ITS PRODUCTS BY OTHERS. PLEASE NOTE THAT ALL SAFE PRACTICES AS SPECIFIED BY THE LOCAL BUILDING CODES, OSHA, AND OTHER STANDARD ORGANIZATIONS SHOULD BE FOLLOWED IN THE SELECTION OF MATERIALS AND/OR METHODS USED IN HANGING, MOUNTING, OR INSTALLING REALACOUSTIX LLC PRODUCTS.

PROPRIETARY AND CONFIDENTIAL
THE INFORMATION CONTAINED IN THIS DRAWING IS THE SOLE PROPERTY OF REALACOUSTIX LLC. ANY REPRODUCTION IN PART OR AS A WHOLE WITHOUT THE WRITTEN PERMISSION OF REALACOUSTIX LLC. IS PROHIBITED

REALACOUSTIX LLC RESERVES THE RIGHT TO CHANGE OR MODIFY PRODUCTS ILLUSTRATED IN THE SHOP DRAWINGS AS NEEDED FOR ANY REASON DEEMS NECESSARY TO IMPROVE THE DESIGN OR MEET CERTAIN WEIGHT, MEASUREMENT, VISUAL, ARCHITECTURAL OR STRUCTURAL REQUIREMENTS.

DRAFTED BY: AB
CHECKED BY:
MODIFIED DATE:
9/9/22
REVISION NUMBER: 1

SD-A02

STEP 1.

NOTE:
ALL CONSTRUCTION MUST BE COMPLETE BEFORE PRODUCT ARRIVES
PRODUCT MUST ACCLIMATE AT LEAST 48 HOURS BEFORE INSTALLING
AREA MUST BE CLEAN, DEBRIS-FREE, & DUST-FREE
READ WARRANTY NOTICE FOR MORE INFORMATION

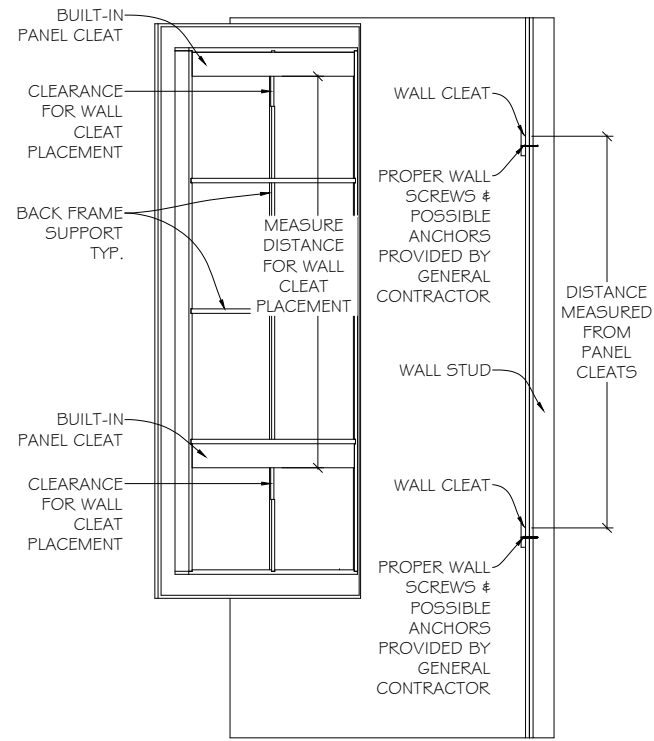

RIGHT VIEW

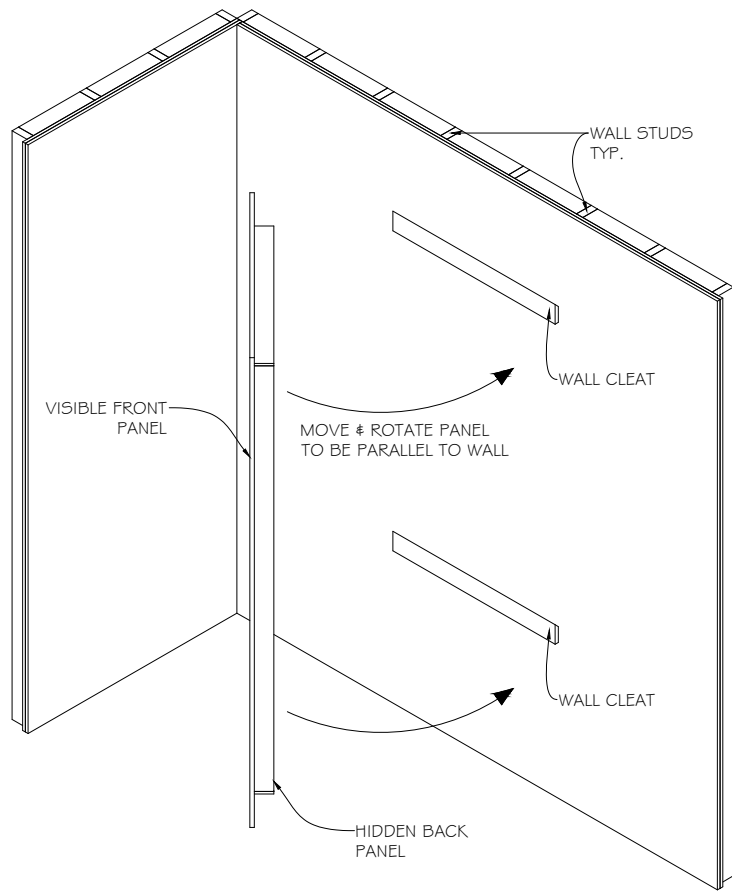

ISOMETRIC VIEW

STEP 2.

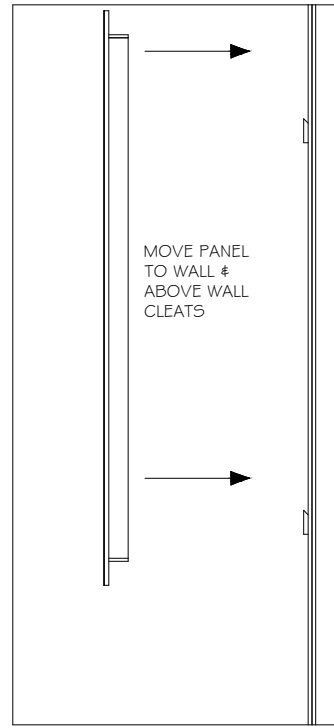

RIGHT VIEW

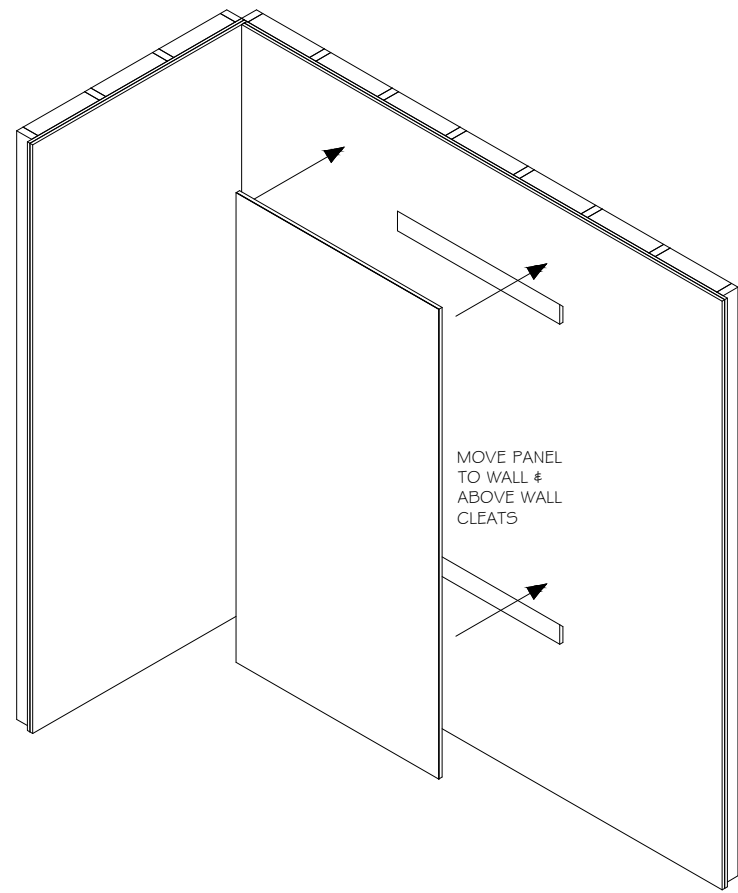

ISOMETRIC VIEW

STEP 3.

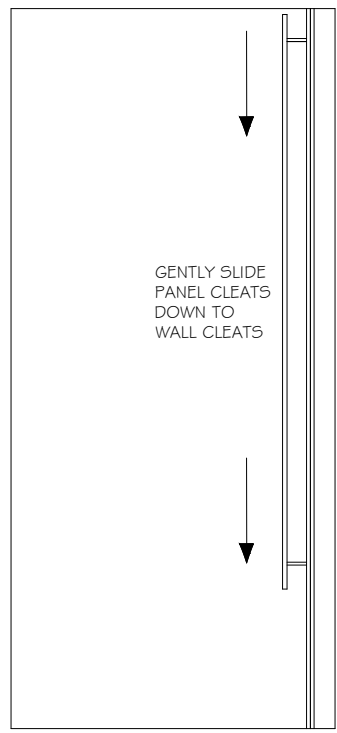

RIGHT VIEW

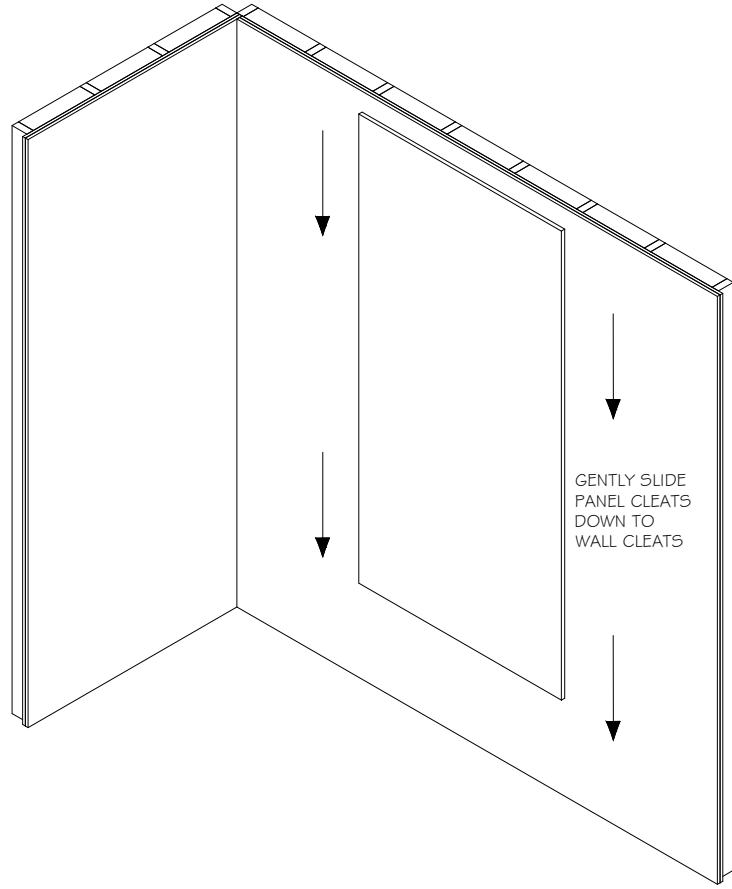

ISOMETRIC VIEW

STEP 4.

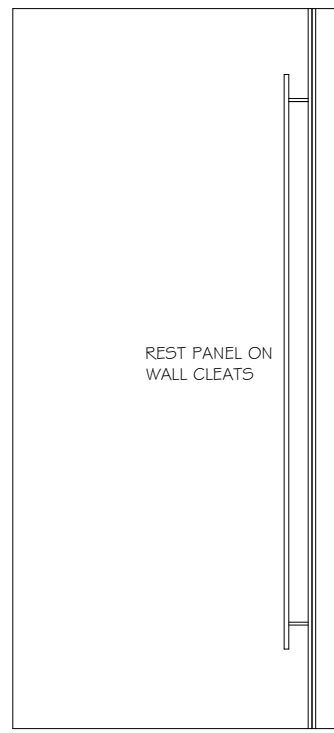

RIGHT VIEW

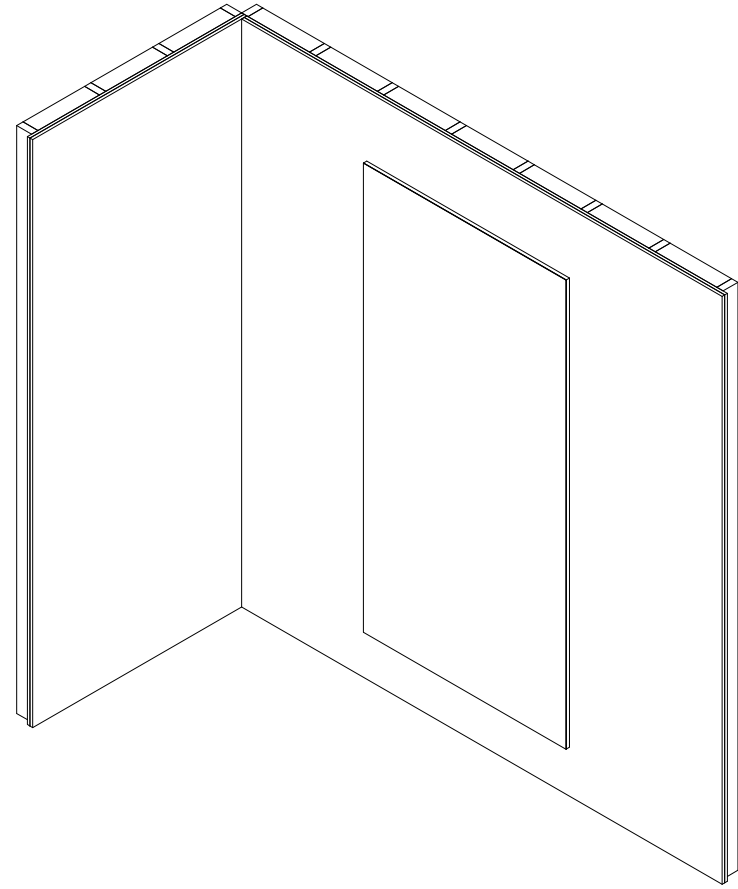

ISOMETRIC VIEW



801-782-1010
2361 B AVE
OGDEN, UTAH 84401
INFO@REALACOUSTIX.COM

INSTALLATION

RECESS FRAME WALL

PLEASE NOTE THAT THESE INSTRUCTIONS ARE FOR GUIDANCE ONLY. REALACOUSTIX LLC, ITS OWNERS, EMPLOYEES AND STAFF SHALL ASSUME NO LIABILITY FOR THE COMPREHENSION OF THESE INSTRUCTIONS OR THE FOLLOWING THEREOF. NO LIABILITY ON THE PART OF REALACOUSTIX LLC SHALL BE ASSUMED FOR THE WORK INVOLVED IN INSTALLATION OF ITS PRODUCTS BY OTHERS. PLEASE NOTE THAT ALL SAFE PRACTICES AS SPECIFIED BY THE LOCAL BUILDING CODES, OSHA, AND OTHER STANDARD ORGANIZATIONS SHOULD BE FOLLOWED IN THE SELECTION OF MATERIALS AND/OR METHODS USED IN HANGING, MOUNTING, OR INSTALLING REALACOUSTIX LLC PRODUCTS.

PROPRIETARY AND CONFIDENTIAL

THE INFORMATION CONTAINED IN THIS DRAWING IS THE SOLE PROPERTY OF REALACOUSTIX LLC. ANY REPRODUCTION IN PART OR AS A WHOLE WITHOUT THE WRITTEN PERMISSION OF REALACOUSTIX LLC. IS PROHIBITED

REALACOUSTIX LLC RESERVES THE RIGHT TO CHANGE OR MODIFY PRODUCTS ILLUSTRATED IN THE SHOP DRAWINGS AS NEEDED FOR ANY REASON DEEMS NECESSARY TO IMPROVE THE DESIGN OR MEET CERTAIN WEIGHT, MEASUREMENT, VISUAL, ARCHITECTURAL OR STRUCTURAL REQUIREMENTS.

DRAFTED BY: AB
CHECKED BY:

MODIFIED DATE:
9/9/22

REVISION NUMBER: 1

SD-A02

STEP 1.

NOTE:
ALL CONSTRUCTION MUST BE COMPLETE BEFORE PRODUCT ARRIVES
PRODUCT MUST ACCLIMATE AT LEAST 48 HOURS BEFORE INSTALLING
AREA MUST BE CLEAN, DEBRIS-FREE, & DUST-FREE
READ WARRANTY NOTICE FOR MORE INFORMATION

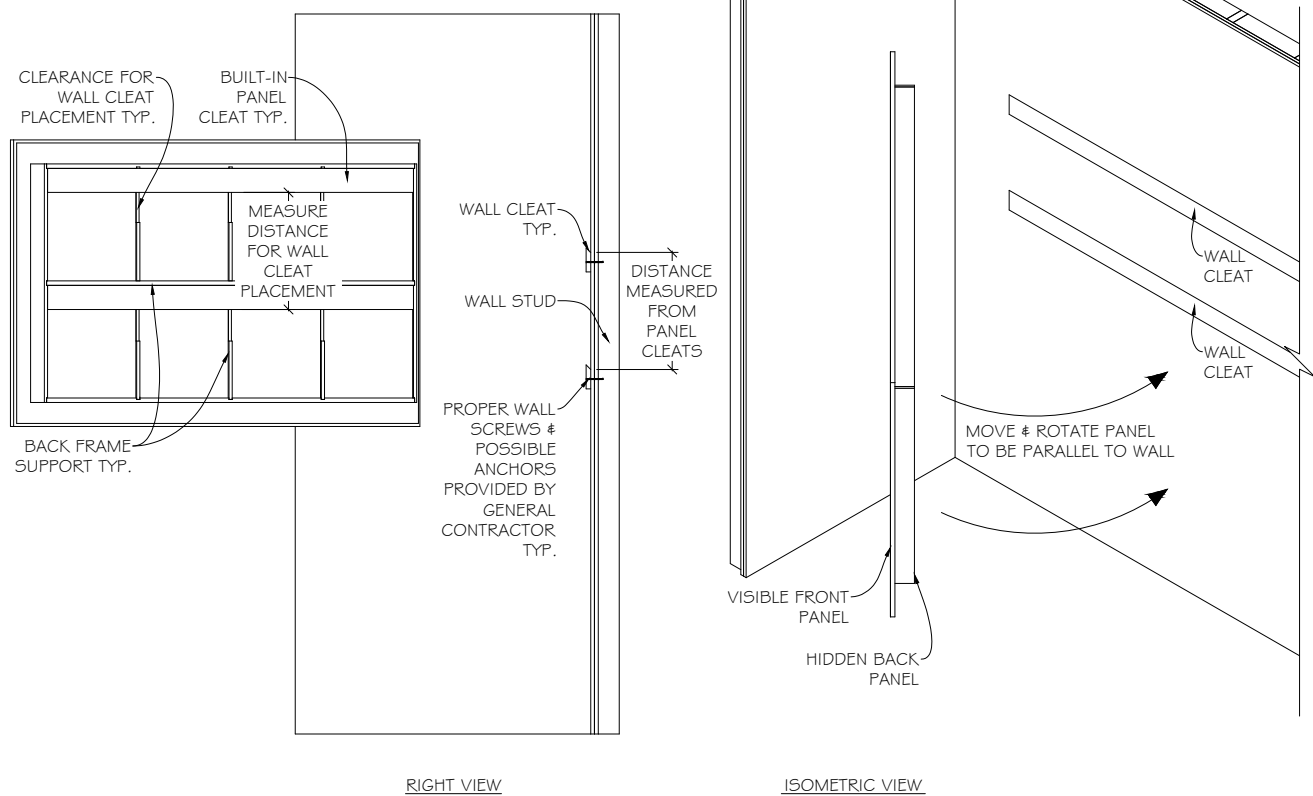

STEP 2.

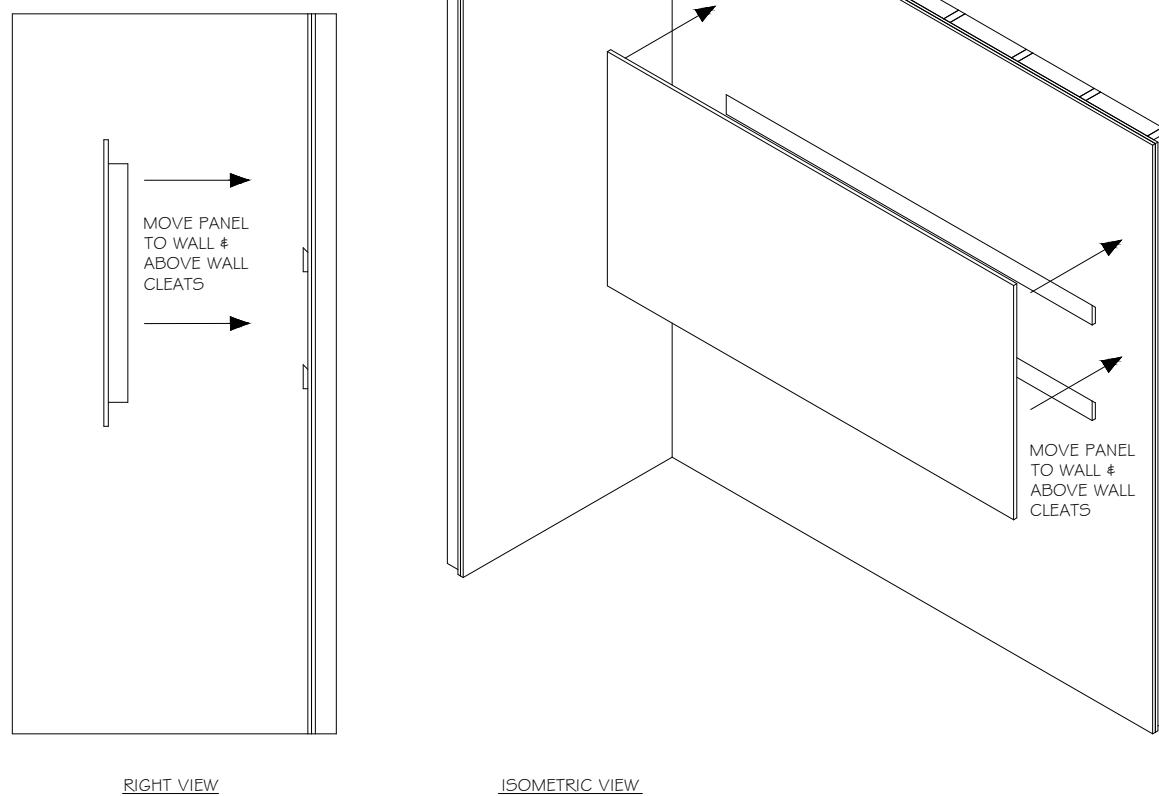

STEP 3.

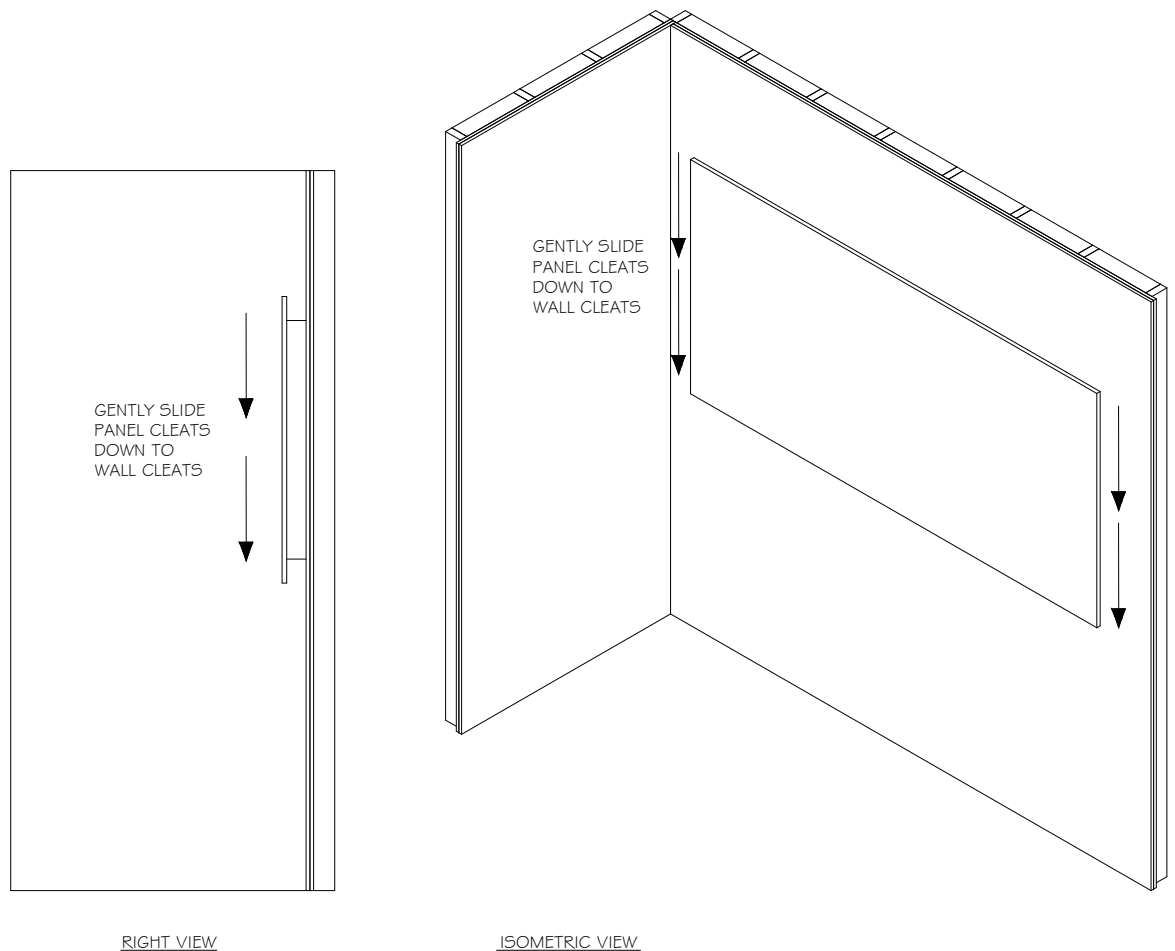

STEP 4.

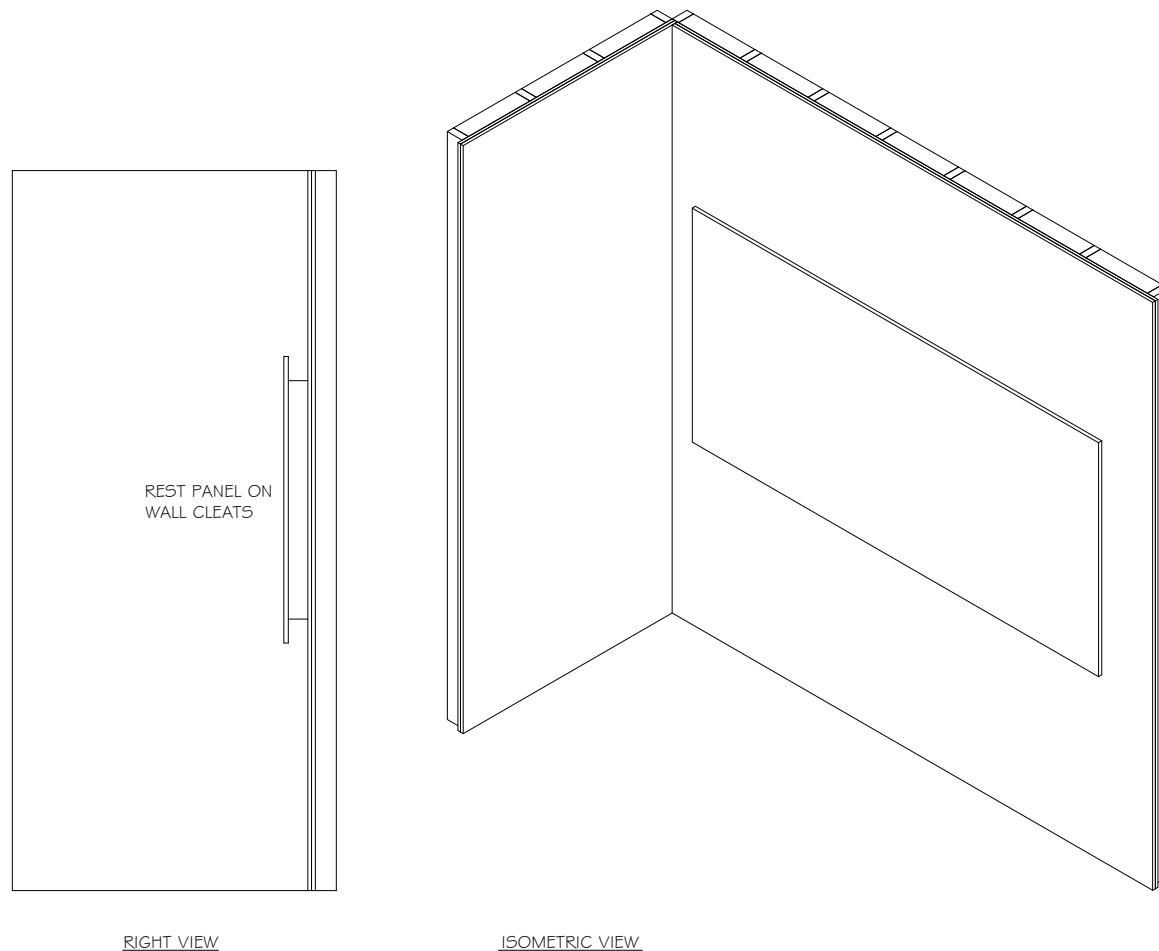

Real Acoustix
801-782-1010
2361 B AVE
OGDEN, UTAH 84401
INFO@REALACOUSTIX.COM

INSTALLATION
RECESS FRAME WALL

PLEASE NOTE THAT THESE INSTRUCTIONS ARE FOR GUIDANCE ONLY. REALACOUSTIX LLC, ITS OWNERS, EMPLOYEES AND STAFF SHALL ASSUME NO LIABILITY FOR THE COMPREHENSION OF THESE INSTRUCTIONS OR THE FOLLOWING THEREOF. NO LIABILITY ON THE PART OF REALACOUSTIX LLC SHALL BE ASSUMED FOR THE WORK INVOLVED IN INSTALLATION OF ITS PRODUCTS BY OTHERS. PLEASE NOTE THAT ALL SAFE PRACTICES AS SPECIFIED BY THE LOCAL BUILDING CODES, OSHA, AND OTHER STANDARD ORGANIZATIONS SHOULD BE FOLLOWED IN THE SELECTION OF MATERIALS AND/OR METHODS USED IN HANGING, MOUNTING, OR INSTALLING REALACOUSTIX LLC PRODUCTS.

PROPRIETARY AND CONFIDENTIAL
THE INFORMATION CONTAINED IN THIS DRAWING IS THE SOLE PROPERTY OF REALACOUSTIX LLC. ANY REPRODUCTION IN PART OR AS A WHOLE WITHOUT THE WRITTEN PERMISSION OF REALACOUSTIX LLC. IS PROHIBITED

REALACOUSTIX LLC RESERVES THE RIGHT TO CHANGE OR MODIFY PRODUCTS ILLUSTRATED IN THE SHOP DRAWINGS AS NEEDED FOR ANY REASON DEEMS NECESSARY TO IMPROVE THE DESIGN OR MEET CERTAIN WEIGHT, MEASUREMENT, VISUAL, ARCHITECTURAL OR STRUCTURAL REQUIREMENTS.

DRAFTED BY: AB
CHECKED BY:
MODIFIED DATE:
8/12/22
REVISION NUMBER: 1

SD-A02